

# CSP 405B

Conduction-cooled capacitor

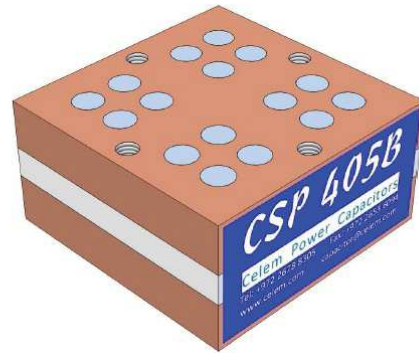

Technology Patented Worldwide

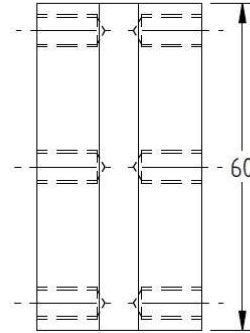
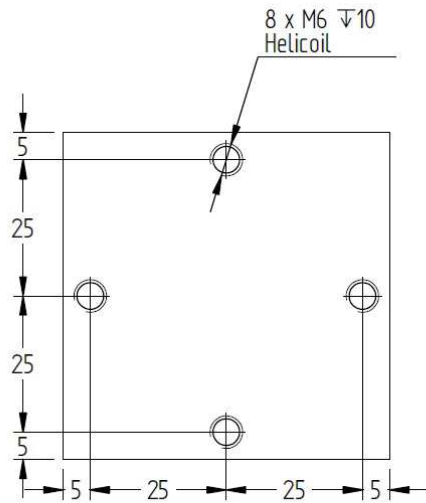

The CSP 405B offers superior electrical characteristics in the same physical dimensions as the CSP 305B.

Please note that the newer CSP 305B/600 has the same physical dimensions as the CSP 405B but is rated for higher voltage and higher current and can carry up to 600kVAR.

## Specifications

Type		CSP 405B							
Dimensions (L x W x H)	mm	60 x 60 x 30.2							
Weight	kg	0.6							
Capacitance (±10%)	μF	0.1 μF	0.2 μF	0.33 μF	0.66 μF	1 μF	1.33 μF	2.6 μF	5 μF
Sinusoidal Voltage	V <sub>rms</sub>	1000				800	900	700	500
Peak_Voltage	V	1410				1130	1270	990	710
Max. Current	A <sub>rms</sub>	400		600		650	850	950	1000
Max. Power	kVA <sub>r</sub>	400							
Freq Range @ Full Power	kHz	637-637	318-318	193-434	97-217	100-168	59-216	50-138	51-80
Stray Inductance	nH	< 5							

**Celem Power Capacitors**



# CSP 405B

Conduction-cooled capacitor



Technology Patented Worldwide

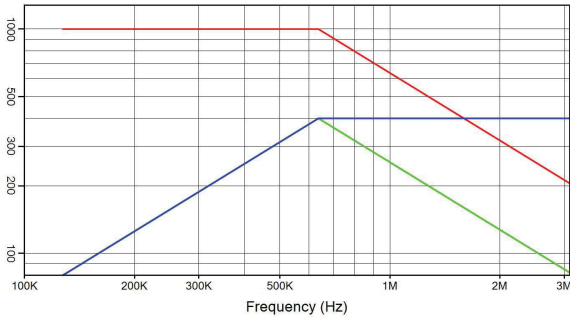

**CSP 405B 0.1 µF 1000 V<sub>rms</sub> 400 A<sub>rms</sub> 400 kVA<sub>r</sub>**  
I(A) — Q(kVA<sub>r</sub>) — V<sub>rms</sub>

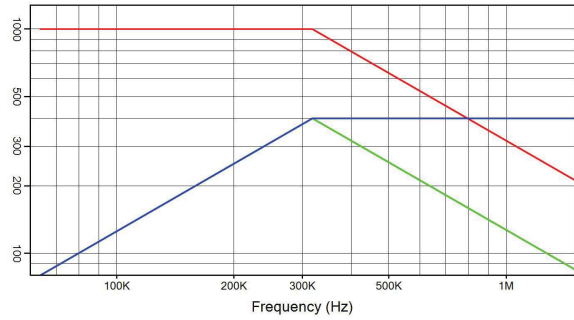

**CSP 405B 0.2 µF 1000 V<sub>rms</sub> 400 A<sub>rms</sub> 400 kVA<sub>r</sub>**  
I(A) — Q(kVA<sub>r</sub>) — V<sub>rms</sub>

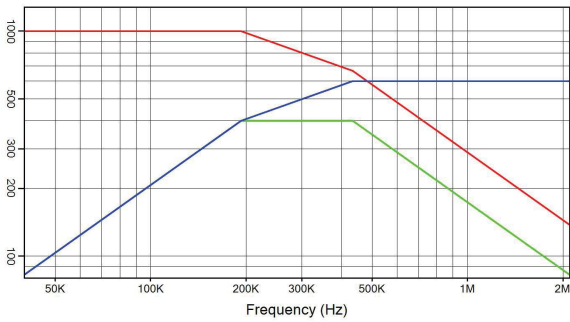

**CSP 405B 0.33 µF 1000 V<sub>rms</sub> 600 A<sub>rms</sub> 400 kVA<sub>r</sub>**  
I(A) — Q(kVA<sub>r</sub>) — V<sub>rms</sub>

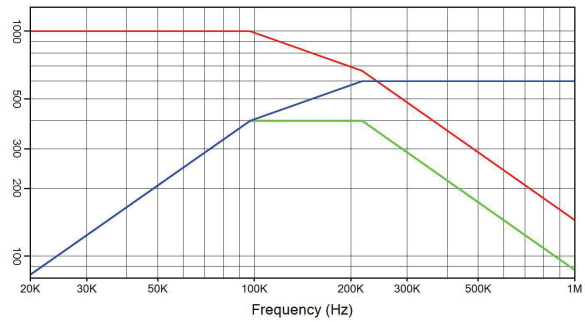

**CSP 405B 0.66 µF 1000 V<sub>rms</sub> 600 A<sub>rms</sub> 400 kVA<sub>r</sub>**  
I(A) — Q(kVA<sub>r</sub>) — V<sub>rms</sub>

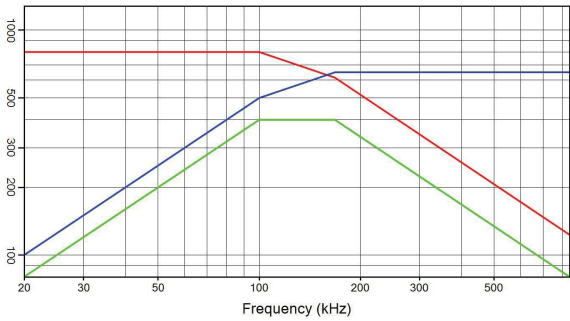

**CSP 405B 1 µF 800 V<sub>rms</sub> 650 A<sub>rms</sub> 400 kVA<sub>r</sub>**  
I(A) — Q(kVA<sub>r</sub>) — V<sub>rms</sub>

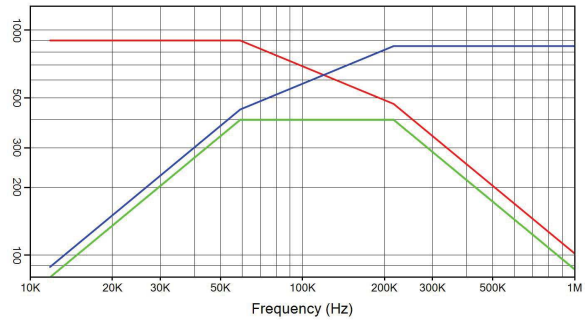

**CSP 405B 1.33 µF 900 V<sub>rms</sub> 850 A<sub>rms</sub> 400 kVA<sub>r</sub>**  
I(A) — Q(kVA<sub>r</sub>) — V<sub>rms</sub>

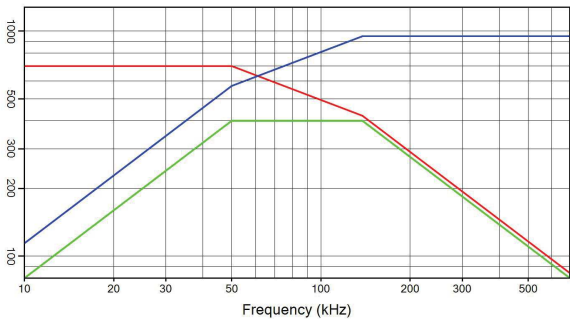

**CSP 405B 2.6 µF 700 V<sub>rms</sub> 950 A<sub>rms</sub> 400 kVA<sub>r</sub>**  
I(A) — Q(kVA<sub>r</sub>) — V<sub>rms</sub>

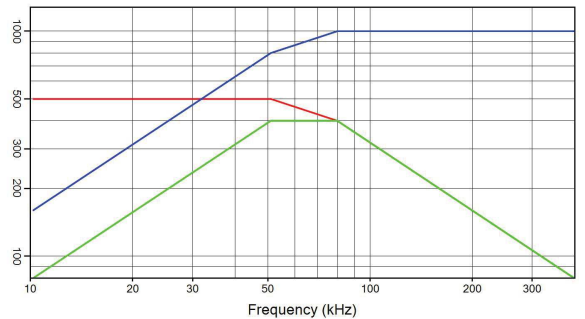

**CSP 405B 5 µF 500 V<sub>rms</sub> 1000 A<sub>rms</sub> 400 kVA<sub>r</sub>**  
I(A) — Q(kVA<sub>r</sub>) — V<sub>rms</sub>

High Frequency Products 50 - 1000 kHz